

PRIVACY FENCE WITH SCALLOPED PICKET INSTALL INSTRUCTIONS

These instructions are to be used as general guidelines for the installation of your vinyl fence under normal installation conditions. Local conditions may exist which may require changes in the recommended methods of installation noted in these instructions such as extreme weather, bad soil conditions such as expansive soil or poorly compacted soil, extreme winds or heat, etc.

1. Before you begin, familiarize yourself with the installation instructions.

2. Tools Required for Installation:

- a. Measuring tape
- b. Wood or Metal Stakes
- c. Post-hole digger / auger
- d. Post-mix concrete
- e. String
- f. Hammer
- g. Shovel
- h. Spray paint
- i. Wheelbarrow
- j. Level
- k. Duct tape to seal rail ends
- l. Saw
- m. Drill
- n. Wrenches (adjust gate)

3. KNOW WHAT'S BELOW BEFORE YOU DIG. Most areas have a call center that you can call to have the utilities located prior to digging. Calling your local utility company is the easiest way to determine who to call. It is important to note that most utility companies will not locate and mark private utility lines that were installed by homeowners or

contractors. Locating utility lines prior to digging may not only save your life, it will also release you of liability in many cases if a line is hit during installation that should have been located but was not. Prior to digging the holes, you should be prepared with emergency numbers to call in the event that a utility line is damaged.

4. FENCE LAYOUT:

When you purchased the fence you likely drew a layout and determined the amount of fencing you needed.

BuyDirectVinylFence.com has a web page that shows how to lay out a fence. It is very helpful to draw the layout of the fence prior to purchasing and installing your vinyl fence.

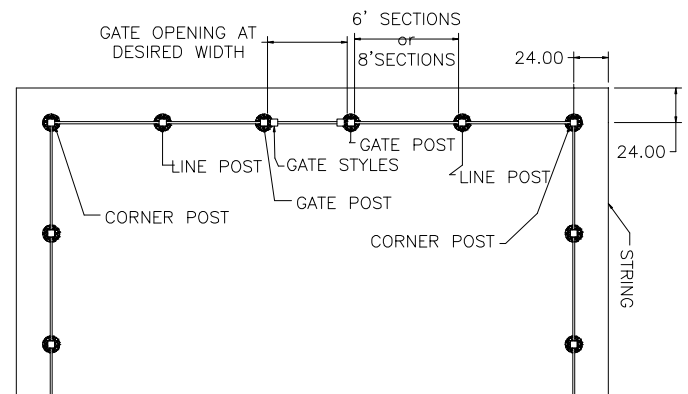

Once you have drawn the fence layout (sample above) and received your product, it is time to mark the locations to dig the holes for the posts.

To start, hammer a stake at each corner and end location of your fence. Pull a

PRIVACY FENCE WITH SCALLOPED PICKETS INSTALL INSTRUCTIONS (cont.)

string line between the end and corner posts. This string line represents where the center of your fence will be. Many people offset the string line at this time so that it represents the edge of the fence line; this will save an extra step when you begin setting the posts (see Figure 4.1).

Determine gate post locations and set stakes at these locations. Once you have pulled the string line tight you can now mark the center of each post along the string line.

Mark the post hole location by beginning at one end of the fence and marking the center to center measurement of each post. For example, if you have an eight foot on center section, you will measure from the center of your first post 96" and mark the ground with upside down marking paint. Continue marking down the string line every 96" until you get to the end post. See (Figure 4.1).

Figure 4.1

Mark the center for each post along the string line

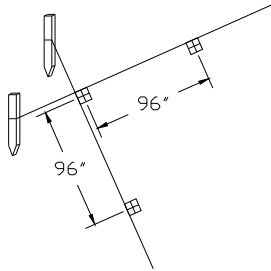

Important: If you have purchased 6' wide panels, the center to center

measurement between any two posts should never exceed 6 feet. If you purchased 8' long panels, the measurement between two posts should never exceed 8'.

LAYOUT CUSTOMIZING:

Most projects will not have fence lines that are exactly 6' or 8' increments and will not come out perfectly when measuring. You will have to make one of a few choices.

Option 1 is to have a short section at the end of the line. (Figure 4.2).

FIGURE 4.2

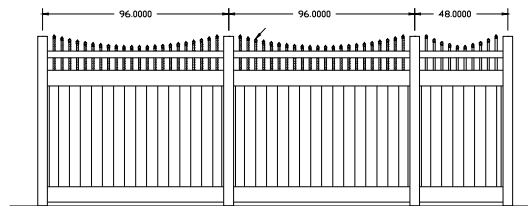

Option 2 is to make each section equal or shorten several of the sections on the fence so that you don't have a short section at the end (Figure 4.3).

FIGURE 4.3

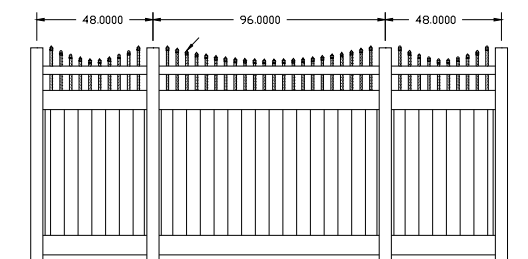

For years I chose option 2 and cut down each section to make every section equal

PRIVACY FENCE WITH SCALLOPED PICKETS INSTALL INSTRUCTIONS (cont.)

but I found that most people don't notice the section that is short and it saves a lot of time and energy to choose option 1.

5. DIGGING THE HOLES & INSTALLING THE POSTS:

Once you have marked the fence post locations, you are ready to dig the holes.

Note: Different soil conditions and climates require different footing requirements. Seek guidance from local professionals and building codes to determine the proper depth and width of footing. In many areas, a 10" wide hole for a 5" post with a depth of 18-24" is standard and adequate but different regions and local codes vary. In frost regions longer posts are required to keep your fence firm in the ground. Please contact us if you are unsure whether your project requires a different length of post than the standard length and we can help you with your individual needs. In some regions, a layer of gravel at the bottom of the post holes is added for extra drainage.

Dig holes using a post-hole digger or an auger. See Figure 4.4. Make sure you have called and located all utility lines and that you adjust your fence accordingly to any conflicts.

**FIGURE 4.4
POST HOLE DETAIL**

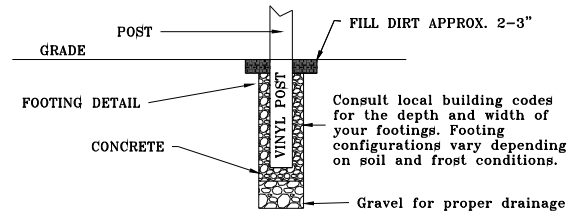

If your project is more than a few holes, you could contact your local small equipment tool rental center to rent a one or two man auger. These generally range from \$60 – 95 a day to rent. If using a one or two man auger, make sure you familiarize yourself with the operator's manual to insure your safety.

Safety Tip: When open holes exist, safety standards should be applied to properly protect the area and notify bystanders of the potential trip and fall hazards that exist with open holes in the ground. Clearly mark the area as a construction zone so others are notified of the dangers that exist.

Once the holes are dug, the easiest way to set posts in a straight line is by using a string line stretched from one end of the fence to the other. To do this, move the stakes you previously used to mark the hole locations over 2" if installing a 4" post, 2.5" if installing a 5" post. The reason you are moving the stakes over is because they were used to mark the center of the holes and now we need to move them over so the string line is

PRIVACY FENCE WITH SCALLOPED PICKETS INSTALL INSTRUCTIONS (cont.)

positioned where the outside of the post should be. See Figure 4.1 and 4.5.

Figure 4.5

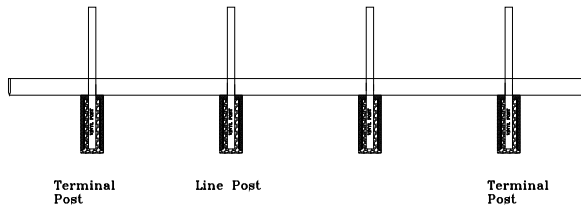

Help Tip: It is important to look often down the line of your fence to make sure that the fence is straight and level and plumb. If something looks a little off, go back and adjust as needed. Once you complete a section of fence it is very easy to push a fence post one way or another and tamp at the base of the post to ensure that the top of the fence is straight and level plumb. See Figure 4.6.

To set the post in a straight line you want to level the post and then place the post just off the string line (you do not want the post touching the string line).

Fill the hole around the post with concrete up to 2" – 3" from top of the hole while keeping the post level and just off of the string.

Plum, square and level the post into position.

You will typically set the post height so the bottom rail has two inches of clearance from the ground. This bottom gap can be adjusted to fit your project's needs.

Continue setting the next post, making sure that distance between the posts is 96" or 72" center to center (spacing varies depending on type of fence you purchased).

Note: At the end of the runs, sections may need to be shortened to maintain desired layout.

Figure 4.6

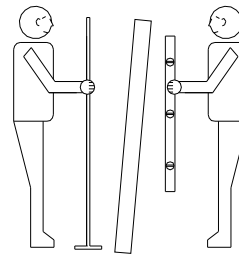

Getting the Height of the Post Right:
 A method commonly used when setting posts is to set the posts close to the right height but primarily focusing on getting the posts straight in a line (post is level and just off the string). Once this has been completed and prior to the concrete setting up, the installer, with the assistance of another will look down the line and pull the post up a little or knock it down by tapping on the top of the post with a block of wood and hammer. The block of wood will help to prevent damage to the vinyl post.

PRIVACY FENCE WITH SCALLOPED PICKETS INSTALL INSTRUCTIONS (cont.)

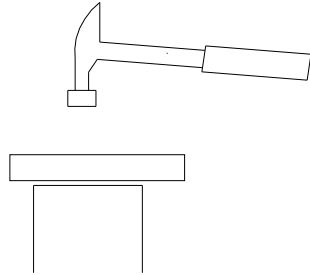

String lines can also be used to help keep the post level but remember that string lines sometimes sag in the middle so it is important to visually look down the top of the fence to make sure the fence is straight. See Figure 4.7.

Figure 4.7



The posts can also be set the right height by placing the bottom rails in the posts and using a level to make sure the posts are set level. When the level is placed on the rails you will know whether to lower raise or lower a particular post.

Grade Note: Contact your fence supplier prior to ordering your fence if your fence grade rises or slopes more than 5%. The fabricator will adjust for this condition by enlarging the routed holes on the posts and rails. The holes on the rails where the pickets go may also need to be

enlarged to compensate for the grade changes.

GATE POSTS:

Gate posts should be set at the same time the other fence posts are being installed and using the same methods.

Note: Depending on the size of the gate, it is often advisable to make the post footing larger to support the weight of the gate. A standard 12" x 24" footing is usually adequate for gates up to 6' wide but often installers make this footing larger to be on the safe side and we recommend doing this.

The spacing between the two gate posts is **VERY IMPORTANT** depending on the size of gate you purchased and extra care should be taken to make sure that gate posts are set at the right distance between the gate posts.

Leveling and plumbing the post is essential to the proper operation of the gate. If gate posts are not level, you will notice it when the gates have been installed. Un-level posts also prevent the gates from operating properly.

The distance between the posts for a gate should be the distance of the gate you purchased. For example, a 4' wide gate purchased from Buy Direct Vinyl Fence will have a distance between the posts of 48". We have made the gates smaller to compensate for the hinge and latch hardware and so you just need to make sure that you set the gate post to the

PRIVACY FENCE WITH SCALLOPED PICKETS INSTALL INSTRUCTIONS (cont.)

measurement of the gate size you ordered (4' is 48"; 5' is 60", etc.).

Privacy With Scalloped Pickets Gate

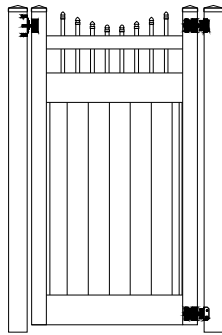

During the post installation process, there is no need to worry about the hardware or any other gate factors, simply focus on setting the gate post to the right spacing height, level and plumb. (See concrete mounting section if you are installing your post on concrete.)

Concrete Mount Details with Tower:

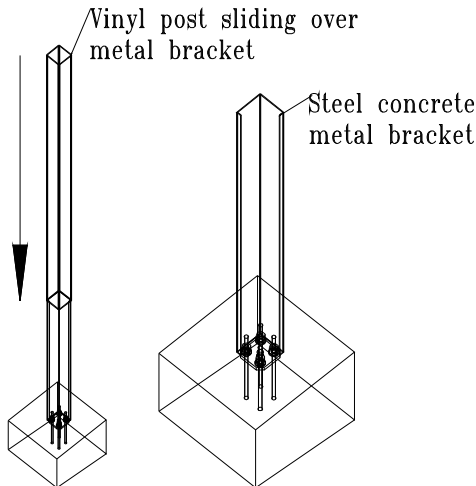

INSTALLING THE BOTTOM RAILS:

Insert the bottom rail into the post, maintaining an equal distance on both sides of the rail. If the section you are installing is smaller than 96" on center, you will need to cut the rail to make it the right length for that section. To do this, measure the distance between the posts and add 3" for the desired rail length. The rail must extend into the post 1 1/2" on both posts. The stiffener in the bottom rail will also need to be cut to the same length as the rail. See Figure 4.8.

Figure 4.8

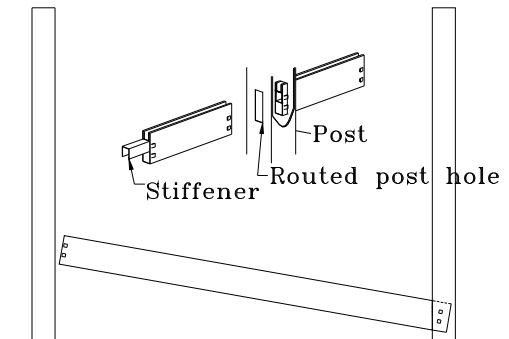

The rail can be secured to the post by using notches, rail clips, screws, or glue tabs. Notching is commonly used when a notching tool is available, when one is not available, glue tabs, screws, or rail clips are acceptable methods to secure the rail.

If using glue tabs to secure the rail, once the rail has been properly inserted 1 1/2" into each post you will need to glue a

PRIVACY FENCE WITH SCALLOPED PICKETS INSTALL INSTRUCTIONS (cont.)

glue tab under the bottom rail on both sides of the rail. The glue tab should be glued against the post to prevent movement of the rail.

Rail clips or notching the rails may also be used in lieu of glue tabs. Each method prevents the rail from coming out of the post at a later time.

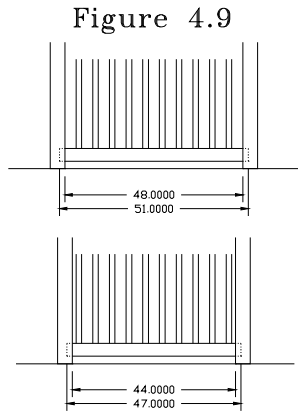

Once the rail has been properly inserted 1 1/2" into each post you will need to glue a glue tab under the bottom rail on both sides of the rail, in a manner where it rests against the post to prevent movement of the rail. Rail clips may also be used in lieu of a glue tab, both work great to prevent the rail from popping out of the post at a later time.

Picket Fence Note: In the event that you have a short section and the middle and top rail need to be cut where the rail has been routed for pickets, it is important to make sure that the distance from the first and last picket hole in the rail are equal in distance to each post (this involves

cutting both ends of the rail). In other words, sometimes you may have to cut off a portion from each side of the rail to make sure that the distance from the post to the distance of the first picket is equal on both sides of the panel. See Figure 4.9.

INSTALLING THE U-CHANNEL

Screw the U-channel to the posts on each side of panel. The U-channel covers the cut of the last picket on a privacy fence and provides a clean look to the fence. It also prevents any gaps from becoming visible in the event the post shifts after installation due to any ground movement settling. See Figure 2.1.1.

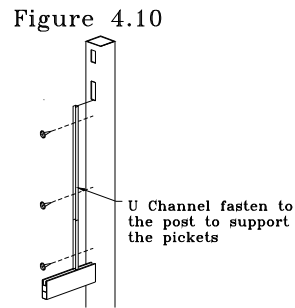

Insert the pickets into the bottom rail.

INSTALLING THE T&G PICKETS

Insert the pickets into the bottom rail of each section by starting at one side and inserting the tongue and groove pickets in the bottom rail. See Figure 4.11.

PRIVACY FENCE WITH SCALLOPED PICKETS INSTALL INSTRUCTIONS (cont.)

Figure 4.11

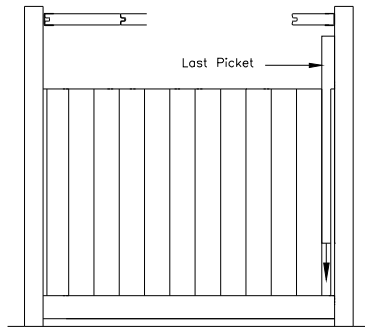

Once all of the pickets have been inserted into a section, measure the distance between the post and the last full picket you can fit on the panel. Measure and cut the last picket to the right width and slide the last picket into place next to the post and into the U-channel attached to the post. This cut is best performed with a table saw however standard field tools such as a sawzall or skill saw can be used effectively. When using a skill saw it is best to use a blade with the maximum amount of teeth per blade such as a plywood blade.

Safety glasses should be worn at all times when cutting and installing vinyl fence to protect your eyes. Manuals for any equipment should be read and understood prior to use of any machinery and equipment. Safety is always first.

INSTALLING THE MIDDLE RAIL

Insert the middle rail into one side of the post and then into the lower tongue and groove pickets. Push the top rail down until all of the pickets are in place inside

of the top rails pocket. Once all pickets are inserted into the middle rail, slide the middle rail into the middle post hole 1 1/2" making sure that each side has 1 1/2" of rail inserted into both posts. The middle rail can be secured by a set screw or rail clip against the post. See Figure 4.12.

Figure 4.12

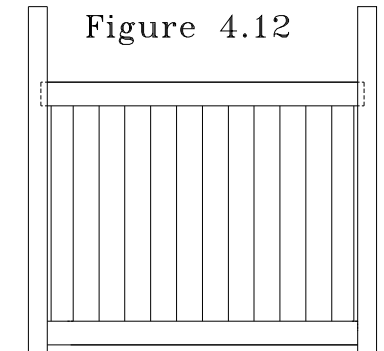

INSTALLING THE TOP RAIL

Insert the top rail into the posts and secure it with a setscrew, notchers, or rail clip. See Figure 4.13.

Figure 4.13

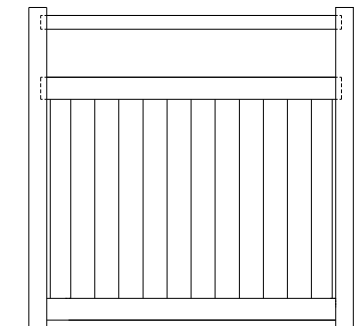

PRIVACY FENCE WITH SCALLOPED PICKETS INSTALL INSTRUCTIONS (cont.)

INSTALLING THE TOP PICKETS

Install the pickets by pushing them into the top routed hole in the top rail and sliding the picket all the way down until it inserts into the mid-rail. The pickets are pre-notched and will lock into place once pushed into the middle rail. See Figure 4.14.

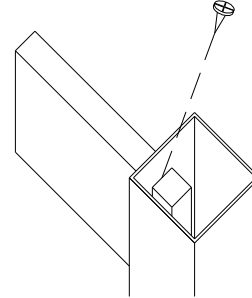

Figure 4.14

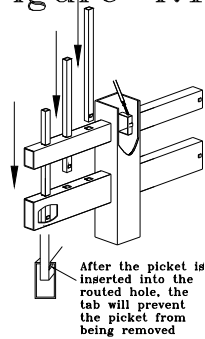
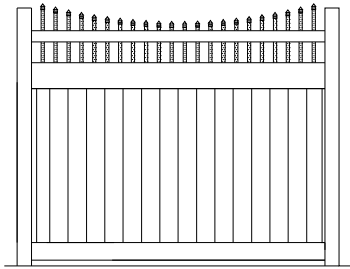

Figure 4.14



Secure the top rail by placing a set screw or rail clip into the rail and next to the inside wall of the post.

PRIVACY FENCE WITH SCALLOPED PICKET INSTALL INSTRUCTIONS (cont.)

Once the fence has been installed, it is now time to complete the gates.

Gate Posts and Hardware:

There are different methods that can be used to make a gate posts stronger such as adding steel inserts and/or concrete to the inside of gate posts.

We prefer the method of adding 2, 1/2" pieces of rebar to the post and filling the post with concrete. We have used this method on thousands of gates and we feel this method has been tried and proven. See Figure 4.15

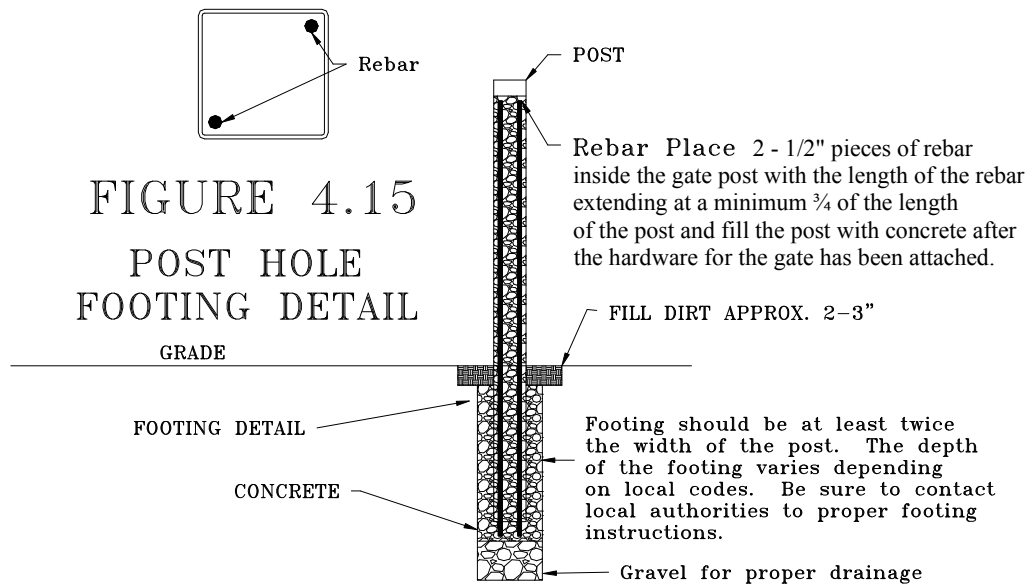

Prior to filling the posts with concrete it is important to screw the gate hardware on the gate posts so you are not screwing into a post filled with concrete. Gate hardware placement does not have to be exact and placement should look something similar to the gate specification diagram provided. At this point the gate hardware should be secured only to the post that will hold the gate up and not the gate itself. See Figure 4.16.

PRIVACY FENCE WITH SCALLOPED PICKET INSTALL INSTRUCTIONS (cont.)

Privacy With Scalloped Pickets Gate
Figure 4.16

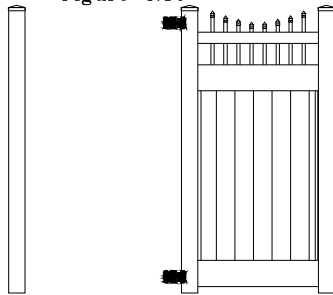

When mixing concrete for gate posts it is important to get a good consistency, too thick and the concrete will not form properly as it is rocky and doesn't fill into the post properly, too soupy and the concrete will run down the rails and not be strong enough as the concrete is diluted with water (many put tape on the end of the rails that insert into gate posts to prevent the concrete from flowing back into the rail).

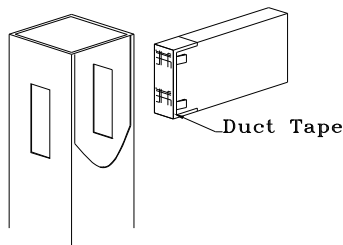

Once you have the right consistency, pour the concrete inside the post and fill the post with concrete. Typically installers use a cup or Gatorade bottle that has been cut at the top to form a funnel. Concrete will likely spill down the side of the post during this stage of the installation. Concrete can be wiped off easily if it is wiped off before the concrete is allowed to cure. Typically we let the concrete dry a little on the outside of the post as we have found it wipes off easier with a dry cloth. If the concrete is on the vinyl for extended period the concrete can be difficult to remove. When concrete is wet and with the help of a little water the concrete will wipe off with a cloth or a sponge.

Let the concrete in the post cure prior to hanging the gate. Cure time varies from geographic location and time of year. During summer months in most locations, this can be the next day. During winter months we have seen this time vary from 1-4 days.

Alternative concrete products may want to be used such as quick curing concrete to speed up this process. Another option is to use a metal stiffener inside of the gate post in lieu of concrete. We have these available and can sell them as requested.

PRIVACY FENCE WITH SCALLOPED PICKET INSTALL INSTRUCTIONS (cont.)

Once the concrete has cured, the gate can be attached to the hardware by adjusting the hinges to the desired gate width and holding or blocking the gate up at the desired height and screwing the hinges to the gate. See figure 4.17.

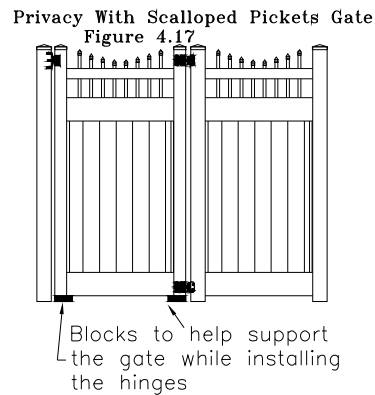

Secure the hinges to the gate with the provided screws and adjust the hinges to make sure the gaps on both sides of the gate are equal and the gate is level and swinging properly.

Attach the latch to the gate. The latch pin should fit loose into the latch.

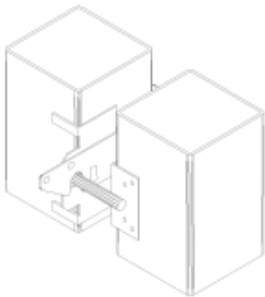

Secure Caps:

Glue caps onto top of post with PVC glue, making sure not to spill or drip glue onto the fence, as certain glues will sometimes yellow.

Enjoy your fence. Follow our maintenance instructions to ensure proper maintenance care for your vinyl fence.